



**MARVEL**

**CAR • SKATE • BIKE • SWIMMING • OUTDOOR • SKI**



**LEISURE • ACTIVITY • JOY • HAPPINESS • FUN • ENERGY**



**STAR WARS**



# CONTENTS

<b>I. ABOUT US</b> .....	<b>4</b>	<b>VIII. OUTDOOR ACCESSORIES</b> .....	<b>44</b>
<b>II. PROPERTIES</b> .....	<b>5</b>	1. PADDLES .....	45
<b>III. TRADE FAIR</b> .....	<b>6</b>	2. FLYING DISCS .....	46
<b>IV. B2B PLATFORM</b> .....	<b>7</b>	3. CATCH BALLS .....	47
<b>V. BIKE AND SCOOTERS ACCESSORIES</b> ..	<b>8</b>	4. SKIPPING ROPES .....	48
1. IN-MOLD HELMETS .....	9	<b>IX. SWIMMING ACCESSORIES</b> .....	<b>49</b>
2. BIKE HELMETS .....	12	1. KICKBOARDS .....	50
3. BIKE BASKETS .....	13	2. BODYBOARDS .....	51
4. BOTTLE COVERS .....	15	3. SWIMMING CAPS .....	52
5. CABLE LOCKS .....	16	4. SWIMMING GOGGLES .....	53
6. CHAIN LOCKS .....	17	5. MASK & SNORKEL .....	54
7. METAL BELLS .....	18	<b>X. WINTER ACCESSORIES</b> .....	<b>55</b>
8. BIKE HORNS .....	19	1. SKI HELMETS .....	56
9. PINWHEELS .....	20	2. SKI GOGGLES & GLOVES .....	58
10. STREAMERS .....	21	<b>XI. TRAVEL ACCESSORIES</b> .....	<b>59</b>
11. BIKE GLOVES .....	22	1. CAR SUNSHADES 44x35 .....	60
12. ELBOW & KNEE PROTECTORS .....	23	2. ROLLER SUNSHADES .....	66
13. METAL BALANCE BIKES .....	24	3. BACK SEAT PROTECTORS .....	68
14. WOODEN BALANCE BIKES .....	26	4. BACK SEAT ORGANIZERS .....	70
15. THREE WHEELS SCOOTERS .....	27	5. POP-UP TOY ORGANIZERS .....	72
16. TWO WHEELS SCOOTERS .....	28	6. NECK PILLOWS & SEAT BELT COVERS .	74
<b>VI. SKATE ACCESSORIES</b> .....	<b>30</b>	7. EYE MASKS .....	76
1. SKATE HELMETS & ACCESSORIES ....	31	8. BABY ON BOARD SIGNS .....	77
2. PENNY BOARDS .....	36	9. BOOSTER CAR SEATS .....	78
3. WOODEN SKATEBOARDS .....	38	10. CAR SEATS GROUP 2/3 .....	80
<b>VII. VINTAGE ACCESSORIES</b> .....	<b>41</b>	11. ICE SCRAPERS .....	82
1. VINTAGE BIKE BELLS .....	42	<b>XII. DISPLAYS</b> .....	<b>84</b>

Here  
the Adventure  
Begins

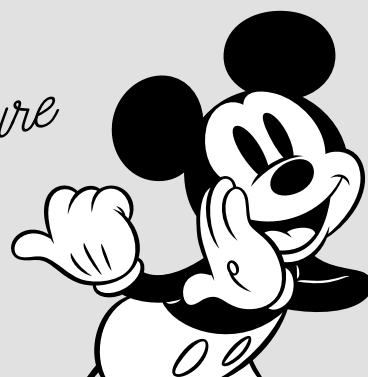

# ABOUT US

**Company Seven Polska** is the manufacturer and Disney licensee of automotive and sport products for children. Taking into account safety, comfort and satisfaction of children and their parents, we constantly increase the range of products that will intensify outdoor activities of the whole family and make children comfortable during the journey.

All products are designed according to the latest trends and with the most popular Disney characters.



TRAVEL



BIKE

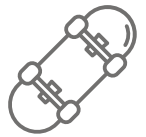

SKATE



OUTDOOR



SWIMMING



SKI

## Product categories

We take the opportunity to present our products and meet our customers at the most relevant domestic and international trade fairs, among other:



Kids Time



spielwarenmesse®



KIND + JUGEND



EUROBIKE  
THE GLOBAL SHOW

We cooperate with customers from all market sectors starting from mass market customers, through local distributors, wholesalers and traditional shops to e-commerce from all over Europe. Dropshipping services are also available.

**You are welcome to contact us in case of any queries.**

## Advantages from the cooperation with us

over 15 years on the market

EXPERIENCE

in distribution of Disney sport & travel accessories

LEADER

constantly growing range of products

ASSORTMENT

we listen and respond to customers' needs

CUSTOMER SERVICE

is our priority

QUALITY

ADVANTAGES

# PROPERTIES



© Disney  
 © Disney/Pixar  
 ©2021 MARVEL  
 © & ™ Lucasfilm Ltd.

© Disney. Winnie the Pooh elements are based on the "Winnie the Pooh" works by A.A. Milne E.H. Shepard  
[www.Disney.com](http://www.Disney.com)

# TRADE FAIRS

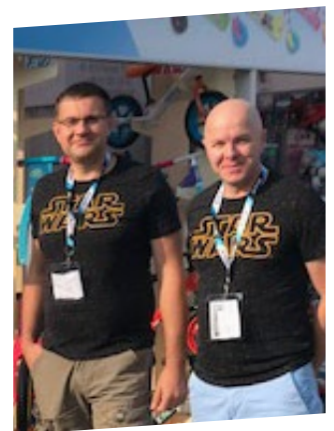
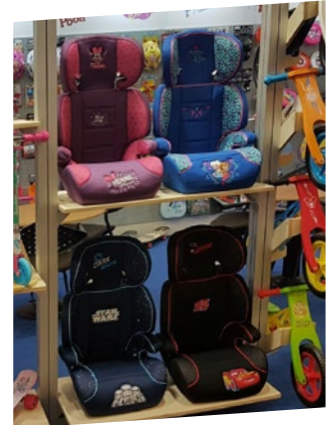

# B2B PLATFORM

## Online ordering system

We offer to our customers individual access to modern and intuitive B2B platform where they can check products availability, place the order, download documents, CSV / XML files, pictures, manuals and.... check it by yourself!

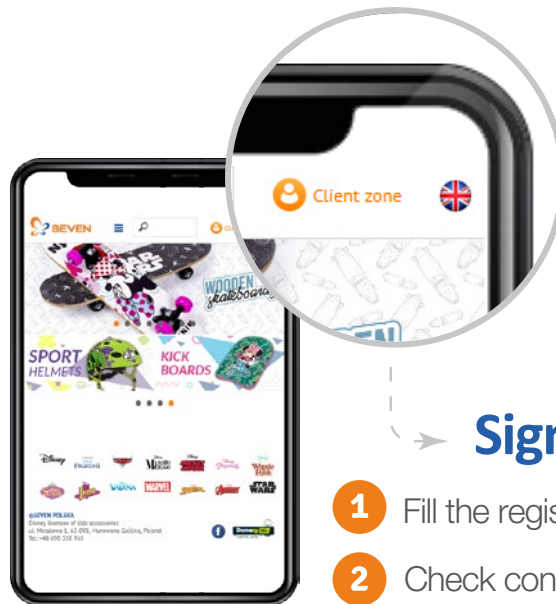

### Sign up

- 1 Fill the registration form
- 2 Check confirmation e-mail
- 3 Sign in and make order



stock availability and ordering

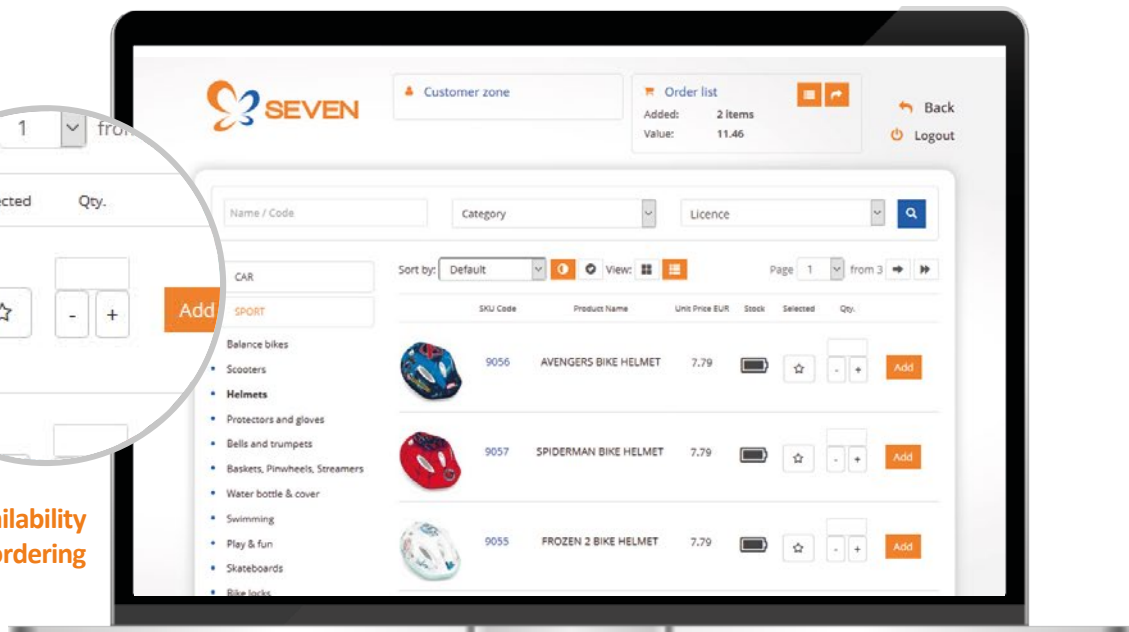

your order history and documents

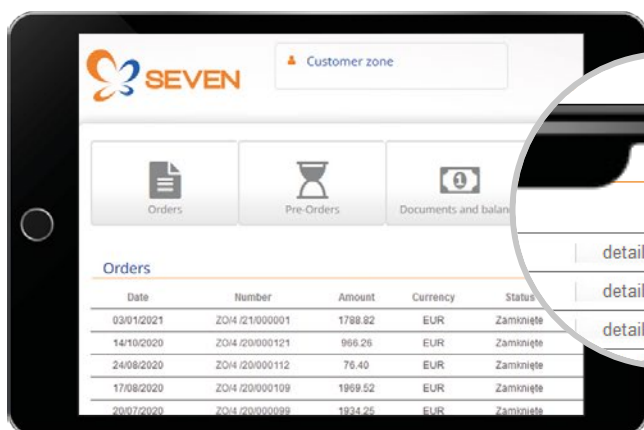

XML & CSV integration

Register now

<https://b2b.sevenpolska.com>

# BIKE AND SCOOTERS

## ACCESSORIES

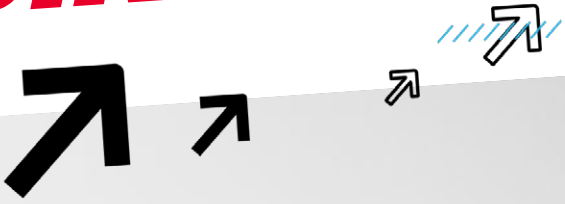
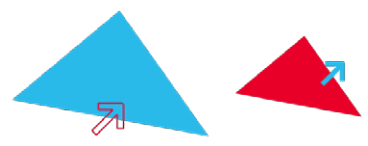

**MARVEL**





# IN-MOLD

## BIKE HELMET

Children bicycle helmet - In-mold technology  
Outer shell is made of PC with color, water  
printing. Inner shell is made of black EPS.

Pad System: Cool Comfort Pads  
Construction: In-Mould  
Vents: 17  
weight: 210g  
size: XS (48-52cm), S (52-56cm)

Norm: EN 1078:2012+A 1:2012



VENTS



EPS



WEIGHT



IN-MOLD



EN 1078



COMFORT  
PADS





From the Movie  
**Disney  
FROZEN**  
art.no.  
9070



From the Movie  
**Disney  
FROZEN**  
art.no.  
9071



Disney  
**Minnie  
Mouse**  
art.no.  
9072



Disney  
**Minnie  
Mouse**  
art.no.  
9073





art.no.  
9076



art.no.  
9077



art.no.  
9074



art.no.  
9075



new  
desings!



art.no.  
9056



art.no.  
9055



art.no.  
9057



art.no.  
9002



art.no.  
9003



art.no.  
9042



art.no.  
9005





art.no.  
9033

STAR  
WARS



art.no.  
9040

STAR  
WARS









art.no.  
9004

Disney  
PRINCESS



TECHNICAL DETAILS

-  HEAD CIRCUMFERENCE 52-56 CM
-  245-260 GR WEIGHT
-  ADJUSTING KNOB
-  PVC SHELL
-  SOFT CHIN STRAP
-  EN 1078 STANDARD
-  BOX 4 PCS



MARVEL  
AVENGERS

art.no.  
9230



© MARVEL



From the Movie  
Disney  
FROZEN

art.no.  
9229



MARVEL  
SPIDER-MAN

art.no.  
9231

new  
desings!

Disney  
**MICKEY  
MOUSE**

art.no.  
9202



Disney  
**MINNIE  
MOUSE**

art.no.  
9203



Disney  
**PRINCESS**

art.no.  
9204



Disney  
**Winnie  
the  
Pooh**

art.no.  
9205



**STAR  
WARS**

art.no.  
9035



**STAR  
WARS**

art.no.  
9219







Disney PIXAR  
**CARS**

art.no.  
9228



**TECHNICAL DETAILS**

-  COLORFUL PVC
-  EASY TO MOUNT
-  STRAPS INCLUDED
-  FITS ALL BIKES AND SCOOTERS
-  BOX 30 PCS



art.no.  
9212



art.no.  
9213



art.no.  
9214



art.no.  
9215



art.no.  
9217



art.no.  
9216







art.no.  
9218



art.no.  
9220

**TECHNICAL DETAILS**

-  DURABLE AND EASY TO CLEAN
-  VERSATILE SIZE
-  EASY TO ATTACH
-  BOX 100 PCS



CARABINER FIXING



PRACTICAL LOOP



VELCRO STRAP



HOW TO USE





**MARVEL**

art.no.  
9221



From the Movie  
**Disney FROZEN**

art.no.  
9222



Disney  
**Minnie Mouse**

art.no.  
9224



**MARVEL SPIDER-MAN**

art.no.  
9223



**TECHNICAL DETAILS**

**EASY INSTALL**

EASY TO MOUNT



DIAMETER 12 MM



LENGTH 65 CM



FITS ALL BIKES AND SCOOTERS



2 KEYS

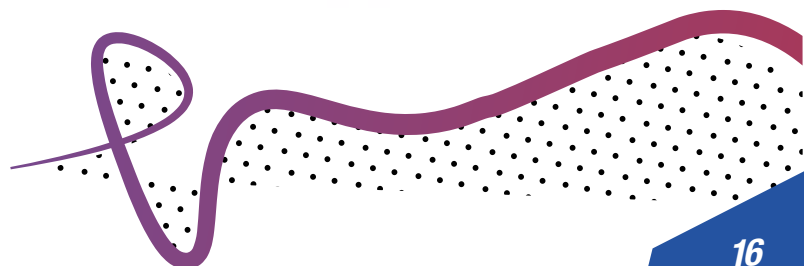



**MARVEL**

art.no.  
9226



TECHNICAL DETAILS

**EASY INSTALL** EASY TO MOUNT

Ø DIAMETER 3 MM

↗ LENGTH 120 CM

✔ FITS ALL BIKES AND SCOOTERS

🔑 2 KEYS

Disney  
**Minnie  
Mouse**

art.no.  
9225

TECHNICAL DETAILS

- MAKES LOUD SOUND
- EASY TO INSTALL
- CIRCUMFERENCE 5,5 CM
- BOX INNER 10, OUTER 100

art.no. 9153

From the Movie  
**Disney FROZEN**

A light green metal bell with a circular face showing Elsa and Anna. The text 'Believe in the JOURNEY' is written on the face. The bell has a matching green base and two small handles.

art.no. 9104

**Disney PRINCESS**

A pink metal bell with a circular face showing Belle and Cinderella. The bell has a matching pink base and two small handles.

art.no. 9154

**MARVEL AVENGERS**

A dark blue metal bell with a circular face showing Iron Man, Captain America, and Hulk. The bell has a matching blue base and two small handles.

art.no. 9155

**MARVEL SPIDER-MAN**

A red metal bell with a circular face showing Spider-Man. The text 'PROTECTOR' and 'NEW YORK' is visible. The bell has a matching red base and two small handles.

art.no. 9131

**Disney PIXAR Cars**

A red metal bell with a circular face showing Lightning McQueen. The text 'Lightning 95' and 'McQueen' is visible. The bell has a matching red base and two small handles.

art.no. 9105

**Disney Winnie the Pooh**

A yellow metal bell with a circular face showing Winnie the Pooh, Piglet, and Eeyore. The bell has a matching yellow base and two small handles.

art.no. 9103

**Disney MINNIE MOUSE**

A pink metal bell with a circular face showing Minnie Mouse. The text 'HAPPY Days' is visible. The bell has a matching pink base and two small handles.

art.no. 9102

**Disney MICKEY MOUSE**

A blue metal bell with a circular face showing Mickey Mouse on a motorcycle. The text 'MICKEY' is visible. The bell has a matching blue base and two small handles.

art.no. 9034

**STAR WARS**

An orange metal bell with a circular face showing a Star Wars control panel. The text 'STAR WARS' is visible. The bell has a matching orange base and two small handles.

art.no. 9130

**STAR WARS**





A dark blue metal bell with a circular face showing a Stormtrooper helmet. The text 'STAR WARS' is visible. The bell has a matching dark blue base and two small handles.

**STAR  
WARS**

art.no.  
9116



TECHNICAL DETAILS

-  MAKES LOUD SOUND
-  EASY INSTALL VERY EASY TO ASSEMBLE
-  CIRCUMFERENCE 6,5CM, 14 CM TALL
-  MADE OF METAL
-  BOX INNER 5, OUTER 50

From the Movie  
**Disney  
FROZEN**

art.no.  
9156

From the Movie  
**Disney  
FROZEN**

art.no.  
9115



Marvel  
**SPIDER-MAN**

art.no.  
9157

Disney · PIXAR  
**CARS**

art.no.  
9112



Disney  
**MINNIE  
MOUSE**

art.no.  
9129

Disney  
**PRINCESS**

art.no.  
9113









From the Movie  
**Disney FROZEN**

art.no.  
 9159

**TECHNICAL DETAILS**

-  BIKE AND SCOOTER PINWHEEL
-  EASY AND QUICK TO MOUNT
-  DIAMETER 17 CM
-  BOX 50 PCS



**MARVEL AVENGERS**

art.no.  
 9160



**MARVEL SPIDER-MAN**

art.no.  
 9161



Disney · PIXAR  
**Cars**

art.no.  
 9117



Disney  
**MICKEY MOUSE**

art.no.  
 9119



Disney  
**MINNIE MOUSE**

art.no.  
 9120



Disney  
**PRINCESS**

art.no.  
 9121



Disney  
**Winnie the Pooh**

art.no.  
 9122



**STAR WARS**

art.no.  
 9123



**STAR WARS**

art.no.  
 9124



From the Movie  
Disney  
**FROZEN** art.no.  
9158



Disney  
**MINNIE  
MOUSE** art.no.  
9126



Disney  
**Winnie  
the  
Pooh** art.no.  
9128

Disney  
**PRINCESS** art.no.  
9127



TECHNICAL DETAILS

**EASY  
INSTALL** QUICK ASSEMBLY

**PROFIT** LENGTH 21CM

**BOX** BOX INNER 20, OUTER 200

art.no. 9058 From the Movie **Disney FROZEN**



art.no. 9016 **Disney MICKEY MOUSE**



art.no. 9015 **Disney MINNIE MOUSE**



art.no. 9059 **MARVEL AVENGERS**



art.no. 9060 **MARVEL SPIDER-MAN**



art.no. 9014 **Disney PRINCESS**



art.no. 9044 **Disney-Pixar Cars**



art.no. 9039 **STAR WARS**







art.no. 9041 **STAR WARS**



art.no. 9017 **Disney Winnie the Pooh**



- TECHNICAL DETAILS**
-  DURABLE MATERIALS
  -  ELASTIC FIBER
  -  VELCRO STRAPS
  -  SOFT GRIPS
  -  BOX INNER 10, OUTER 100

From the Movie  
Disney  
**FROZEN**

art.no.  
9061



art.no.  
9006



MARVEL  
**AVENGERS**

art.no.  
9062



art.no.  
9063



Disney  
**MINNIE MOUSE**

art.no.  
9009



art.no.  
9010



**STAR WARS**





art.no.  
9038



art.no.  
9037



TECHNICAL DETAILS

-  ANATOMICALLY SHAPED
-  DURABLE MATERIALS
-  ADJUSTABLE STRAP
-  EN 14120 STANDARD
-  BOX INNER 6 , OUTER 24



From the Movie  
**Disney  
FROZEN**

art.no.  
9945

© Disney



TECHNICAL DETAILS

EVA TYRES, 12"

2,7 KG WEIGHT

ABEC 5 BEARINGS

BOX 1 PC

**MARVEL  
AVENGERS**

art.no.  
9943



**MARVEL  
SPIDER-MAN**

art.no.  
9944



Disney · PIXAR  
**CARS**

art.no.  
9900







art.no.  
9902



art.no.  
9903



art.no.  
9904



art.no.  
9905



art.no.  
9912



ANTI-SLIP GRIPS

QUICK RELEASE CLAMPS

COMFORTABLE SEAT

STEEL BEARINGS

EVA TYRES

ANTI-SLIP FOOTREST

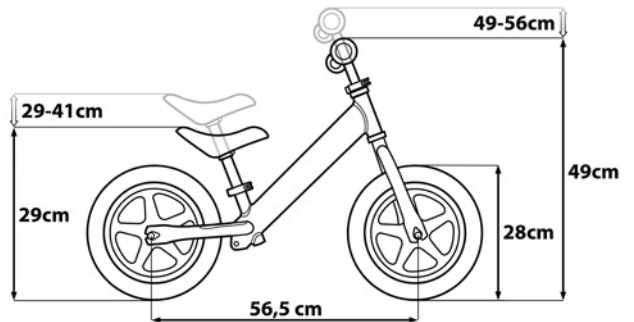

# WOODEN BALANCE BIKES



art.no.  
9906



art.no.  
9907



art.no.  
9908



art.no.  
9909



art.no.  
9910



art.no.  
9911



art.no.  
9913

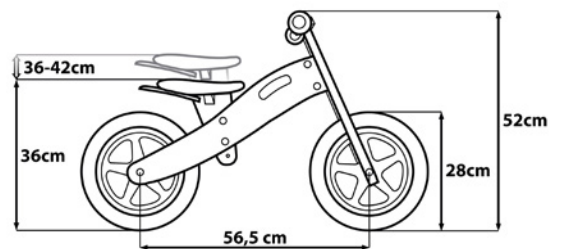
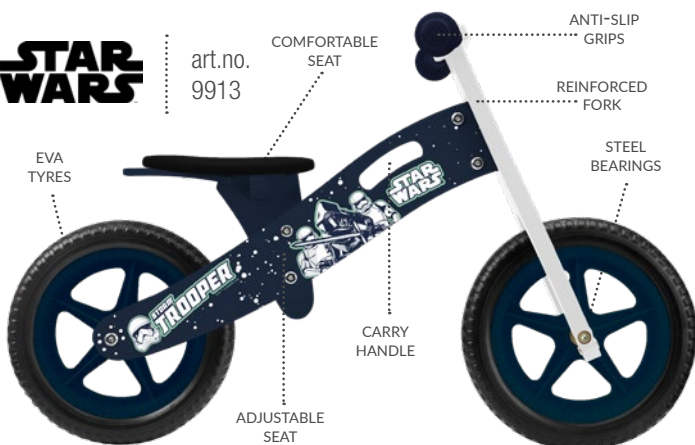

## TECHNICAL DETAILS

EVA TYRES, 12"

2,2 KG WEIGHT

ABEC 5 BEARINGS

BOX 1 PC

From the Movie  
**Disney FROZEN**

art.no.  
9949



Disney  
**MICKEY MOUSE**

art.no.  
9916



Marvel  
**SPIDERMAN**

art.no.  
9948



Disney · PIXAR  
**CARS**

art.no.  
9914



Disney  
**MINNIE MOUSE**

art.no.  
9917



Disney  
**Winnie the Pooh**

art.no.  
9918



**STAR WARS**

art.no.  
9919

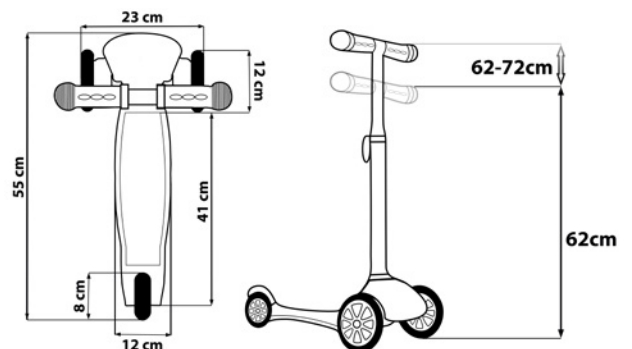







From the Movie  
Disney  
**FROZEN**

art.no.  
9954

© Disney



TECHNICAL DETAILS

-  POLYURETHANE WHEELS
-  2,1 KG WEIGHT
-  ABEC 7 BEARINGS
-  BOX 6 PCS



art.no.  
9947



art.no.  
9946



art.no.  
9921



art.no.  
9923





art.no.  
9924



art.no.  
9925



art.no.  
9926



art.no.  
9927



art.no.  
9928



EASY FOLDING  
MECHANISM

FOOT  
BREAK

NON-SLIP  
PLATFORM

NON-SLIP  
RUBBER HANDLES

ADJUSTABLE  
HEIGHT

STEEL  
BEARINGS

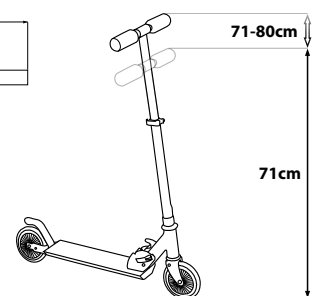
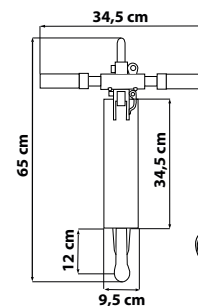

# SKATE

## ACCESSORIES



Disney

Minnie Mouse







Disney  
**Minnie Mouse**

art.no.  
9981



Disney  
**Minnie Mouse**

art.no.  
9980

TECHNICAL DETAILS	
	DURABLE ABS SHELL
	EN 1078 STANDARD
	400 G WEIGHT
	HEAD CIRCUMFERENCE 54-58 CM
	BOX 4 PCS

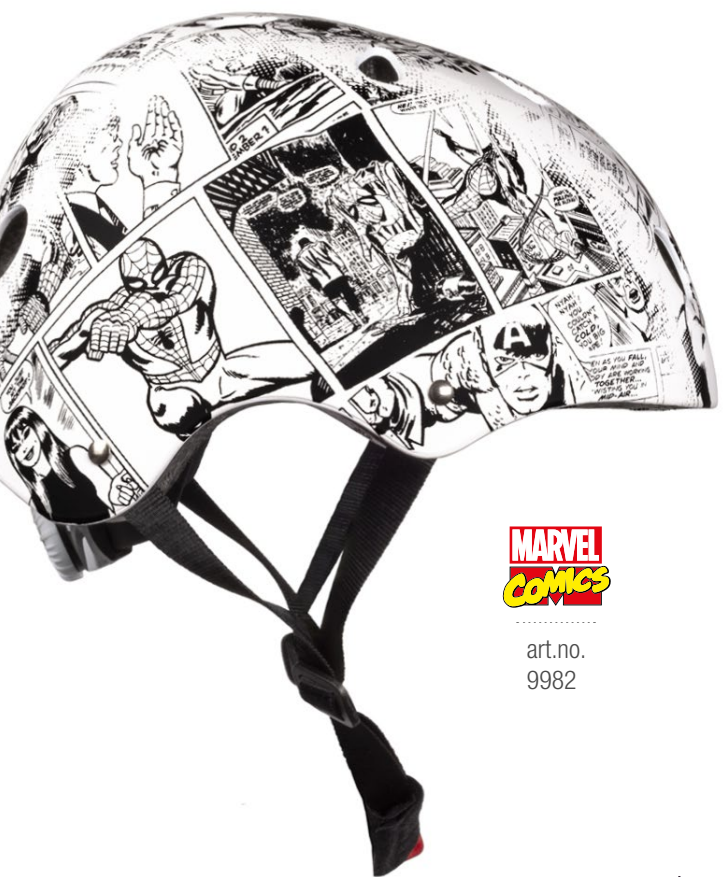

**MARVEL**  
**COMICS**

art.no.  
9982



From the Movie  
Disney  
**FROZEN**

art.no.  
9978

new!

DESINGS



art.no.  
9064



art.no.  
9051



art.no.  
9066



art.no.  
9065





art.no.  
9026

**STAR  
WARS**



**STAR  
WARS**

art.no.  
9022



TECHNICAL DETAILS



SIZE WRIST 14X9 CM  
SIZE KNEE 17,5X X 13 CM, ELBOW 16X9,5 CM



ANATOMICALLY SHAPED



DURABLE MATERIALS



MATERIAL NYLON, POLYURETHANE



EN 14120 STANDARD



BOX INNER 4, OUTER 24



**STAR  
WARS**

art.no.  
9021



© & ™ Lucasfilm Ltd.



art.no.  
9023



art.no.  
9018



art.no.  
9067



art.no.  
9052



art.no.  
9024

From the Movie  
Disney  
**FROZEN**



From the Movie  
Disney  
**FROZEN**

art.no.  
9019



Disney  
**SOY LUNA**

art.no.  
9020



art.no.  
9025

Disney  
**SOY LUNA**



MARVEL  
**AVENGERS**





.....  
art.no.  
9937



MARVEL  
**AVENGERS**

.....  
art.no.  
9938

TECHNICAL DETAILS

-  ABEC 7 STEEL BEARINGS
-  PU 60 X 45 MM WHEELS
-  BOX 4 PCS
-  DURABLE ALUMINUM TRUCKS
-  NON-SLIP AND DURABLE DECK

MARVEL  
**SPIDER-MAN**

.....  
art.no.  
9939



MARVEL  
**COMICS**

.....  
art.no.  
9956



From the Movie  
Disney  
**FROZEN**

art.no.  
9951



Disney  
**Minnie Mouse**

art.no.  
9952



From the Movie  
Disney  
**FROZEN**

art.no.  
9953



art.no.  
9929

**STAR  
WARS**

art.no.  
9932

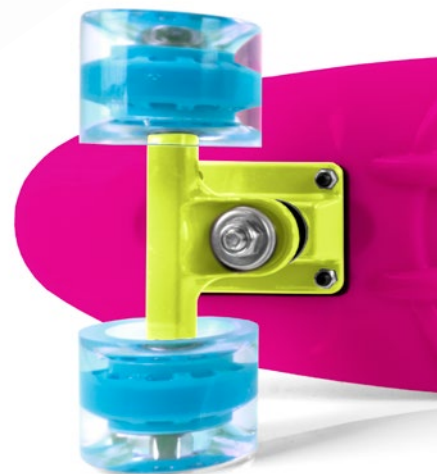



art.no.  
9940







art.no.  
9942



art.no.  
9941

TECHNICAL DETAILS

-  608 Z STEEL BEARINGS
-  50 X 30 MM
-  NON-SLIP AND DURABLE DECK
-  DURABLE ALUMINUM TRUCKS
-  BOX 4 PCS



Disney  
**MINNIE  
MOUSE**

art.no.  
9935



From the Movie  
Disney  
**FROZEN**

art.no.  
9955

**STAR  
WARS**

art.no.  
9934



# MARVEL AVENGERS

© MARVEL



From the Movie  
Disney  
**FROZEN**



# MARVEL SPIDER-MAN

© MARVEL





# VINTAGE





ACCESSORIES



**STAR  
WARS**™



TECHNICAL DETAILS

-  MAKES LOUD SOUND
-  RETRO STYLE
-  CIRCUMFERENCE 8 CM
-  MADE OF METAL
-  BOX INNER 5, OUTER 50, TRAY PACK 6

new  
desings!

art.no.  
9164



art.no.  
9163



art.no.  
9162



art.no.  
9142



art.no.  
9145



art.no.  
9141



art.no.  
9146



art.no.  
9140



art.no.  
9144



art.no.  
9152



art.no.  
9149



art.no.  
9151

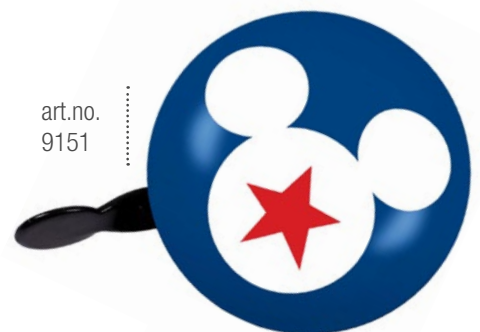

art.no.  
9147



art.no.  
9150



art.no.  
9148



art.no.  
9132



art.no.  
9139



art.no.  
9134



art.no.  
9135



art.no.  
9136



art.no.  
9137



# OUTDOOR ACCESSORIES



**MARVEL**

art.no.  
9800



art.no.  
9801



art.no.  
9802



art.no.  
9803



art.no.  
9813



art.no.  
9814



art.no.  
9815



TECHNICAL DETAILS

MADE OF DURABLE MATERIAL

CIRCUMFERENCE 21 CM

MADE OF PVC

BALL IN THE SET

BOX INNER 6, OUTER 48 SETS

art.no.  
9804



art.no.  
9805



art.no.  
9806



art.no.  
9807



art.no.  
9816



art.no.  
9817



art.no.  
9818



TECHNICAL DETAILS



MADE OF PVC



CIRCUMFERENCE 23 CM



BOX 24 PCS

art.no. 9809  
From the Movie  
**Disney FROZEN**



art.no. 9808  
Disney PIXAR  
**Cars**



art.no. 9811  
**STAR WARS**



art.no. 9810  
Disney  
**MINNIE MOUSE**



art.no. 9842  
MARVEL  
**AVENGERS**







art.no. 9841  
MARVEL  
**AVENGERS**



art.no. 9843  
MARVEL  
**SPIDERMAN**



TECHNICAL DETAILS



-  MADE OF DURABLE MATERIAL
-  CIRCUMFERENCE 18 CM
-  ADJUSTABLE HANDLE
-  BALL IN THE SET
-  BOX 24 SETS



From the Movie  
Disney  
**FROZEN**

art.no.  
9844

TECHNICAL DETAILS

-  MADE OF PVC
-  ROPE LENGTH 2,2 M
-  BOX 100 PCS



Disney  
**Minnie Mouse**

art.no.  
9845



Disney  
**PRINCESS**

art.no.  
9846



# SWIMMING

## ACCESSORIES



From the Movie

Disney  
**FROZEN II**

From the Movie  
Disney  
**FROZEN**

art.no.  
9874



MARVEL  
**AVENGERS**

art.no.  
9859



MARVEL  
**AVENGERS**

art.no.  
9860



MARVEL  
**SPIDERMAN**

art.no.  
9861



Disney PIXAR  
**CARS**

art.no.  
9855



Disney  
**MINNIE MOUSE**

art.no.  
9857



**STAR WARS**

art.no.  
9858



TECHNICAL DETAILS



EASY TO GRIP



SUITABLE FOR SWIMMING POOL OR BEACH



SIZE 26X42 CM



BOX 12 PCS

From the Movie  
Disney  
**FROZEN**

art.no.  
9875



MARVEL  
**AVENGERS**

art.no.  
9879



MARVEL  
**SPIDER-MAN**

art.no.  
9878



Disney PIXAR  
**Cars**

art.no.  
9876



Disney  
**MINNIE MOUSE**

art.no.  
9877



TECHNICAL DETAILS

 EASY TO GRIP

 SUITABLE FOR BEACH

 SIZE 83 X 48 CM

 BOX 4 PCS

From the Movie  
Disney  
**FROZEN**

art.no.  
9880



MARVEL  
**AVENGERS**

art.no.  
9854



MARVEL  
**SPIDER-MAN**

art.no.  
9866



Disney PIXAR  
**CARS**

art.no.  
9850



Disney  
**MINNIE MOUSE**

art.no.  
9852





**STAR WARS**

art.no.  
9853



TECHNICAL DETAILS

 STRETCHABLE

 MADE OF SILICONE

**FITS ALL** ONE SIZE FITS ALL

 BOX 12 PCS

From the Movie  
**Disney  
FROZEN**

art.no.  
9867



**Marvel  
AVENGERS**

art.no.  
9868



**Marvel  
SPIDER-MAN**

art.no.  
9869



Disney PIXAR  
**Cars**

art.no.  
9872



Disney  
**MINNIE  
MOUSE**

art.no.  
9870



**STAR  
WARS**

art.no.  
9873



TECHNICAL DETAILS



ADJUSTABLE RUBBER STRAP



MADE OF SILICONE

**FITS  
ALL**

UNIVERSAL



BOX 24 PCS



From the Movie  
**Disney  
FROZEN**

art.no.  
9862



Disney  
**MINNIE  
MOUSE**

art.no.  
9863



**MARVEL  
SPIDER-MAN**

art.no.  
9865



**MARVEL  
AVENGERS**

art.no.  
9864

**TECHNICAL DETAILS**

 ADJUSTABLE RUBBER STRAP

**FITS ALL** UNIVERSAL

 BOX 12 PCS

# WINTER

## ACCESSORIES









**STAR  
WARS**™

art.no.  
9053

MARVEL  
SPIDER-MAN



TECHNICAL DETAILS

-  SHOCK ABSORBING EPS FOAM
-  HQ REMOVABLE VELOUR LINING
-  EN 1078 STANDARD
-  HEAD CIRCUMFERENCE 55-58 CM
-  350 GR WEIGHT +/- 30GR
-  BOX 6 PCS



IN-MOLD SHELL  
CONSTRUCTION

ADJUSTABLE  
VENTILATION SYSTEM  
- 14 OPENINGS

ADJUSTING  
KNOB

SOFT PADDING  
AND  
CHIN STRAP

SOFT VENTED  
EAR PADS

art.no.  
9054

MARVEL  
AVENGERS





art.no.  
9046

Disney  
**MINNIE  
MOUSE**



art.no.  
9045

**STAR  
WARS**

art.no.  
9047

Disney  
**MINNIE  
MOUSE**



art.no.  
9049

Disney  
**MINNIE  
MOUSE**



SKI GOGGLES - TECHNICAL DETAILS

<b>UV RESISTANT</b>	100% PROTECTION AGAINST UVA	<b>DOUBLE LENS</b>	DOUBLE LENS
<b>WIDE VIEW</b>	WIDE VIEW	<b>S3 LENS</b>	S3 LIGHT TRANSMISSION
<b>ANTI-FOG</b>	ANTI-FOG	<b>SIZE</b>	SIZE 17CM WIDE 10,5 CM TALL
<b>VENTILATION SYSTEM</b>	VENTILATION SYSTEM	<b>BOX</b>	12 PCS

SKI GLOVES - TECHNICAL DETAILS

<b>ADJUSTABLE VELCRO FASTENERS</b>	ADJUSTABLE VELCRO FASTENERS
<b>WATERPROOF COATING</b>	WATERPROOF COATING
<b>SOFT GRIP</b>	SOFT GRIP
<b>BOX</b>	BOX 24 PCS

art.no.  
9048

**STAR  
WARS**



art.no.  
9050

**STAR  
WARS**



# TRAVEL

## ACCESSORIES



From the Movie

Disney  
**FROZEN II**

art.no.  
9339

From the Movie  
Disney  
**FROZEN**



© Disney



From the Movie  
Disney  
**FROZEN**

art.no.  
9322



From the Movie  
Disney  
**FROZEN**

art.no.  
9312



From the Movie  
Disney  
**FROZEN**

art.no.  
9317



MARVEL  
**AVENGERS**

art.no.  
9324



MARVEL  
**SUPER HERO  
ADVENTURES**

art.no.  
9340



MARVEL  
**SPIDERMAN**

art.no.  
9323



TECHNICAL DETAILS

- FITS ALL** FITS ALL CAR MODELS
- EASY INSTALL** EASY TO INSTALL USING SUCTION CAP
- ✓** TWO SUNSHADES IN DIFFERENT DESIGN
- ✓** SIZE 44X35 CM
- ✓** BOX 100 SET

©2021 MARVEL



art.no. 9332  
**MINNIE**

art.no. 9330  
**Disney JUNIOR MICKEY**



art.no. 9331

© Disney

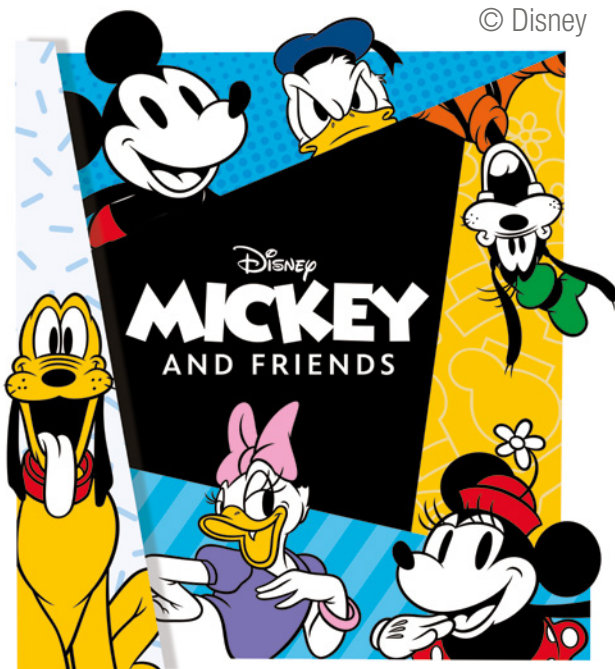

**Disney MINNIE MOUSE**

art.no. 9314



**Disney MICKEY MOUSE**

art.no. 9313



© Disney

# Disney PRINCESS



## Disney PRINCESS

art.no.  
9333

## Disney PRINCESS

art.no.  
9304



## Disney Junior Sofia the First

art.no.  
9306



art.no. 9329  
**Disney**  
**Winnie the Pooh**



art.no. 9305  
**Disney**  
**Winnie the Pooh**



art.no. 9311  
**Disney PIXAR**  
**Cars**



art.no. 9315  
**STAR WARS**



art.no. 9316  
**STAR WARS**







art.no.  
9307



From the Movie  
Disney  
**FROZEN**

art.no.  
9343



new  
desings!



art.no.  
9344



art.no.  
9347



TECHNICAL DETAILS

**FITS ALL** FITS ALL CAR MODELS

**EASY INSTALL** EASY TO INSTALL USING SUCTION CAP

ONE ROLLER SUNSHADE

**SIZE** 36X45CM

**AUTOMATIC ROLLING**

**BOX** 24 PCS



art.no.  
9307



art.no.  
9309



art.no.  
9344



art.no.  
9320



art.no.  
9318



art.no.  
9319





art.no. 9501

From the Movie  
**Disney FROZEN**



art.no. 9508

From the Movie  
**Disney FROZEN**



art.no. 9500

Disney PIXAR  
**Cars**



art.no. 9504

Disney  
**PRINCESS**



art.no. 9502

Disney  
**MICKEY MOUSE**



art.no. 9503

Disney  
**MINNIE MOUSE**



art.no.  
9506



art.no.  
9505









art.no.  
9507



art.no.  
9509



TECHNICAL DETAILS

-  FITS ALL CAR MODELS
-  PROTECTS SEAT FROM DIRT
-  VELCRO STRAPS ON THE TOP, ADJUSTABLE RUBBERS
-  EASY TO CLEAN
-  SIZE 57X45 CM
-  BOX 100 PCS



art.no.  
9536



art.no.  
9534





art.no.  
9535



art.no.  
9537



**TECHNICAL DETAILS**

-  PRACTICAL AND VERSATILE
-  PERFECT FOR TRAVEL
-  BOX 24 PCS



art.no.  
9514



art.no.  
9515



art.no.  
9516



art.no.  
9517



TECHNICAL DETAILS



PRACTICAL AND STABLE



MADE OF SOFT COMPONENTS



SPACIOUS SIDE POCKETS



PERFECT FOR TRAVEL



DIMENSIONS: 37 X 37 X 8 CM



BOX 6 PCS

From the Movie  
Disney  
**FROZEN**

art.no.  
9528



art.no.  
9522



art.no.  
9530



art.no.  
9529



TECHNICAL DETAILS



MADE OF POLYESTER MESH



IT HELPS TO KEEP THE AREA TIDY



IDEAL FOR STORING TOYS, CLOTHES, ETC.



DIMENSIONS: 36 X 36 X 58 CM



BOX 24 PCS



Disney  
**MICKEY  
MOUSE**

art.no.  
9524



Disney  
**MINNIE  
MOUSE**

art.no.  
9525



Disney  
**Winnie  
the Pooh**

art.no.  
9526



**STAR  
WARS**

art.no.  
9527

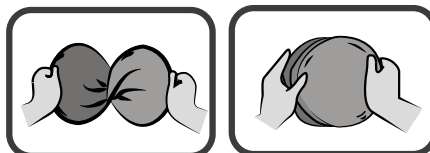

POP-UP / FOLDABLE







art.no.  
9636



art.no.  
9634



TECHNICAL DETAILS

-  MADE OF SOFT MATERIAL
-  DIAMETER 30 CM
-  FILLING 100% POLYBEAD
-  BOX INNER 6, OUTER 48



art.no.  
9637



art.no.  
9638



LYCRA &  
POLY BEAD  
FILLING

SEAT  
BELT COVERS

art.no.  
9641



art.no.  
9639



art.no.  
9642



art.no.  
9643





art.no.  
9603



art.no.  
9602



PLUSH &  
POLY COTTON  
FILLING



art.no.  
9604



TECHNICAL DETAILS

- MADE OF SOFT MATERIAL
- DIAMETER 21 CM
- FILLING 100% PVC COTTON
- BOX INNER 6, OUTER 48



SEAT  
BELT COVERS



art.no.  
9608



art.no.  
9607



art.no.  
9609



TECHNICAL DETAILS

- MADE OF SOFT MATERIAL
- PREVENTS ABRASIONS
- VELCRO FASTENING
- SIZE 19X8 CM
- BOX INNER 12, OUTER 96 PCS



art.no.  
9616



art.no.  
9617



art.no.  
9619







art.no.  
9618



art.no.  
9620



TECHNICAL DETAILS

-  MADE OF SOFT MATERIAL
-  FASTENED WITH RUBBER BAND
-  DIMENSION 18X8,5 CM, RUBBER BAND 34CM
-  BOX INNER 12, OUTER 96 PCS



art.no.  
9611



art.no.  
9625



art.no.  
9610



art.no.  
9613



art.no.  
9612



art.no.  
9623



art.no.  
9624



**TECHNICAL DETAILS**

- MOUNTED TO WINDOW USING SUCTION CAP
- EASY TO MOUNT AND DISMOUNT
- BOX 100 PCS

art.no.  
9721

From the Movie  
**Disney  
FROZEN**



art.no.  
9704

From the Movie  
**Disney  
FROZEN**



**TECHNICAL DETAILS**



FOR CHILDREN WEIGHT 15-36KG



DURABLE CONSTRUCTION



FOR CHILDREN AGE 4-12 YEARS



EASY TO CLEAN, REMOVABLE COVER



EUROPEAN SAFETY STANDARD ECE R44.04



BOX 10 PCS



art.no.  
9708

**Disney  
PRINCESS**



art.no.  
9714

Disney PIXAR  
**Cars**



art.no.  
9701

Disney PIXAR  
**Cars**



art.no.  
9716

**STAR  
WARS**



art.no.  
9713

**STAR  
WARS**



art.no.  
9705

Disney  
**MICKEY  
MOUSE**



art.no.  
9703

Disney  
**Minnie  
Mouse**



art.no.  
9719

MARVEL  
**AVENGERS**



art.no.  
9718

MARVEL  
**SPIDERMAN**





art.no.  
9720



EMBROIDERED  
GRAPHICS

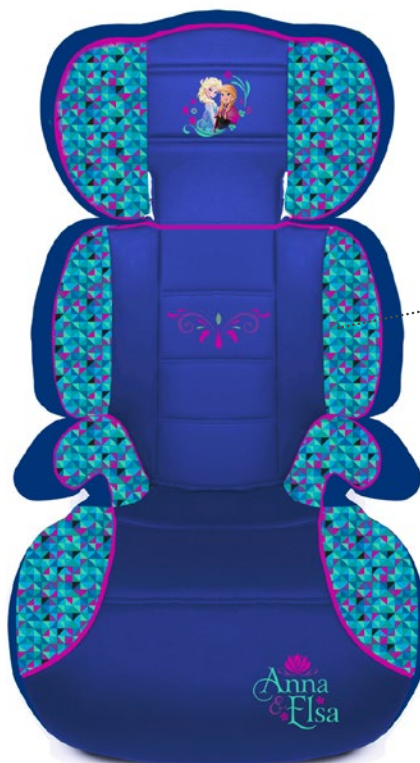

From the Movie  
Disney  
**FROZEN**

art.no.  
9710

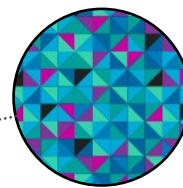

EMBROIDERED  
GRAPHICS



art.no.  
9715

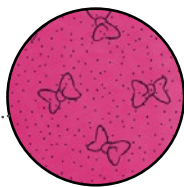

EMBROIDERED  
GRAPHICS



**STAR  
WARS**

art.no.  
9812

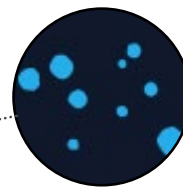

EMBROIDERED  
GRAPHICS



TECHNICAL DETAILS



FOR CHILDREN WEIGHT 15-36KG



FOR CHILDREN AGE 4-12 YEARS



EUROPEAN SAFETY STANDARD ECE R44.04



EASY TO CLEAN, REMOVABLE COVER



COVER MADE OF PVC



HEIGHT ADJUSTABLE HEADREST



EMBROIDERED GRAPHICS



BOX 1 PC





TECHNICAL DETAILS



MADE OF CARTON BOX



DIFFERENT DIMENSIONS



art.no.  
9830



art.no.  
9829



art.no.  
9828



art.no.  
9826



art.no.  
9827



art.no.  
9832



art.no.  
9834



art.no.  
9831



art.no.  
9833



art.no.  
9835





art.no.  
9836

**STAR  
WARS**



art.no.  
9840



art.no.  
9839







art.no.  
9837



art.no.  
9838

TECHNICAL DETAILS

-  SCRAPER WITH GRAPHICS
-  PRODUCT SIZE: 134MM X 114MM
-  ICE BREAKER TEETH WITH HARD RUBBER
-  ITEMS/BOX 200 PCS



art.no.  
9825



Disney  
**MICKEY  
MOUSE**



art.no.  
9823

Disney  
**MINNIE  
MOUSE**

TECHNICAL DETAILS

-  WINDSCREEN SCRAPER WITH POLAR GLOVE
-  SIZE OF THE GLOVE 25X17 CM
-  BOX 20 PCS

art.no.  
9822

**STAR  
WARS**



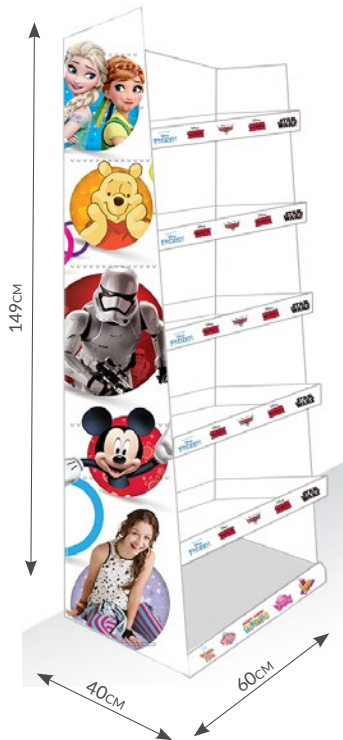

TECHNICAL DETAILS

 MADE OF CARTON BOX

 UP TO 6 SHELVES

 REGULATED HEIGHT OF THE SHELVES

 POSSIBILITY OF MOUNTING HOOKS



# **CONTACT** *US!*



**Stay in touch**



[www.sevenpolska.com](http://www.sevenpolska.com)



[info@sevenpolska.com](mailto:info@sevenpolska.com)



Metalowa 1, 62-095 Murowana Goslina, Poland